

LED Flutlicht

LL-FLS-500W



- ▶ **Kühlung:** SONY 4D, aktive Wärmeableitungstechnologie, modularisiertes BaudeSIGN, größtmögliche Kühlfläche
- ▶ **Optische Linse:** Japan calculus optical DIWL Linse, Lichtdurchlässigkeit von PMMA bis zu 98%.
- ▶ **Beschichtung:** hochfeste Struktur beschichtet mit korrosionsbeständigem Polyesterpulver, echter Korrosionsschutz
- ▶ **Blendung:** exzellentes optisches Design, niedriger UGR, kein Flackern bei Zeitlupenaufnahmen, geeignet für HDTV Live Broadcasting besonders geeignet für Aquariumbeleuchtung
- ▶ CE, (TÜV), RoHS, FCC, DLC und IP67 zertifiziert, 3 Jahre Garantie

Input Voltage	90-305 VAC, 50/60 Hz
AC Current	4A/115VAC 2A/230VAC 1.2A/277VAC
Inrush Current	Cold Start 150A(twidth=570u's measured at 50% peak) at 230VAC
Leakage Current	<0.75mA/277VAC
Power Factor	PF>0.98/115VAC,PF>0.95/230VAC at full lead
LED Light Source	CREE Xlamp
LED Quantity	60PCS
LED Power	500W
Total System Power	528W
Power Supply	MeanWell
Driver Quantity	2PCS
LED Luminous Efficiency	130 -150 lm /W
LED Initial Luminous Flux	65000-75000 Lm
Illuminance Uniformity	>0.8
Color Temperature	2700、3000、3500、4000、5000、5700、6500K
Color Rendering Index	80 or <93
Blue Chips	optional 10-15%
Beam Angle	10°/24°/38°/60°/90°
LED Junction Temperature	≤70°C (@ Ta=25°C)
Working Temperature	-40°C ~ +65°C
Storage Temperature	-40°C ~ +65°C (Best 25°C)
IP Rating	IP67
Net weight	18Kg ohne Montagebügel
Dimming	0-10V, 1-10V, Triac/DALI dimming models
Lifespan	>80,000H
Power Cord	SJT 3X1.31mm ² (16AWG) triple shield wire
Shell Color	Black/Silver/Grey



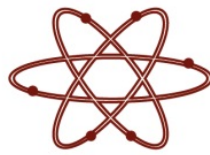

LED Flutlicht

Photometric Results

Beam Angel of 38°

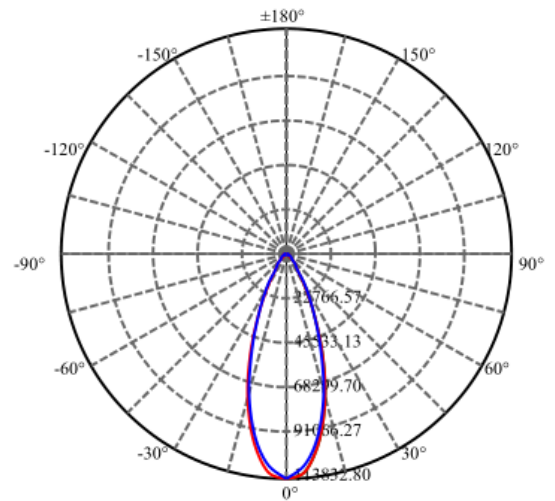
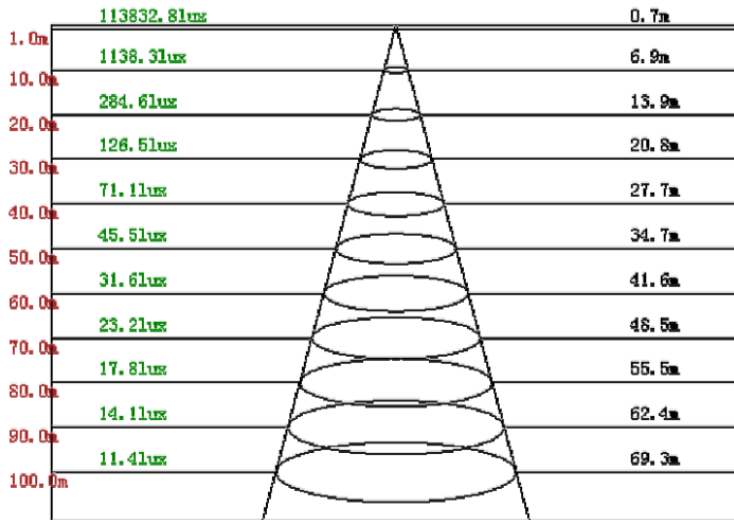

Beam Angel of 60°

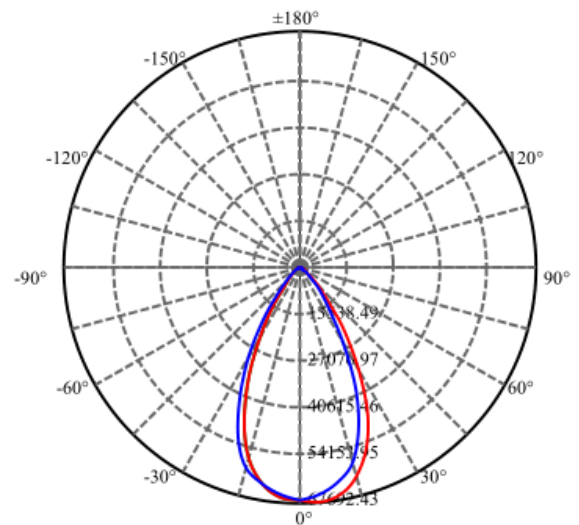
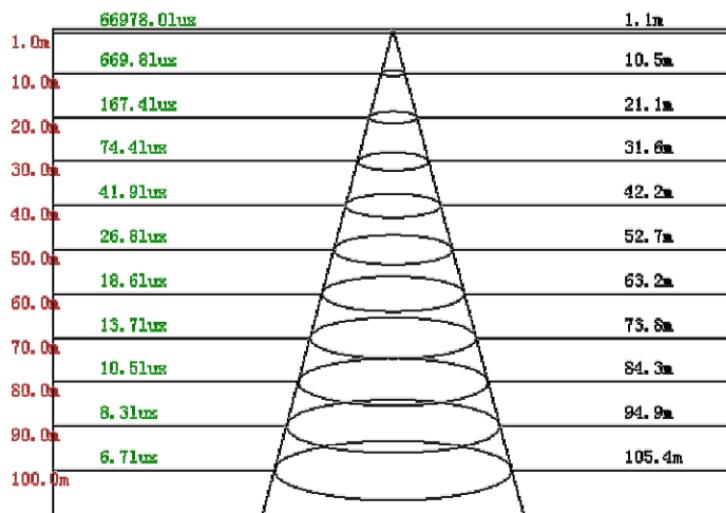

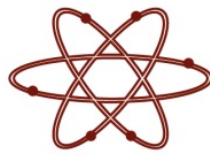

LEDLUMEN®
LED Technologie

LED Flutlicht

Beam Angle

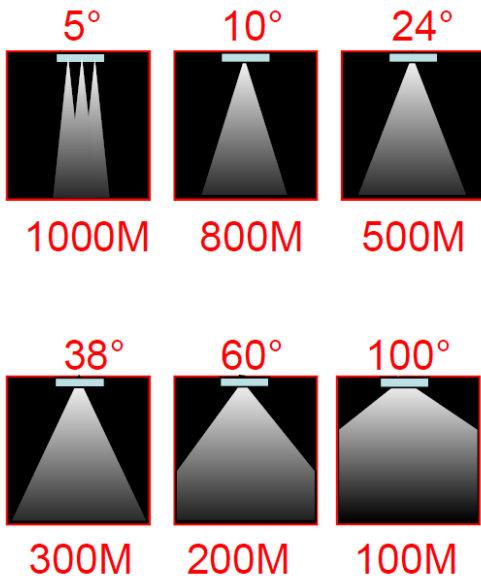

Multi Angle Applications

Two Angle Showing

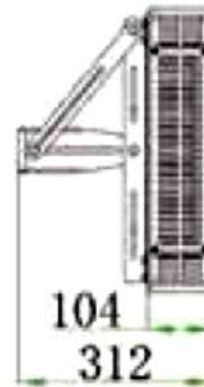
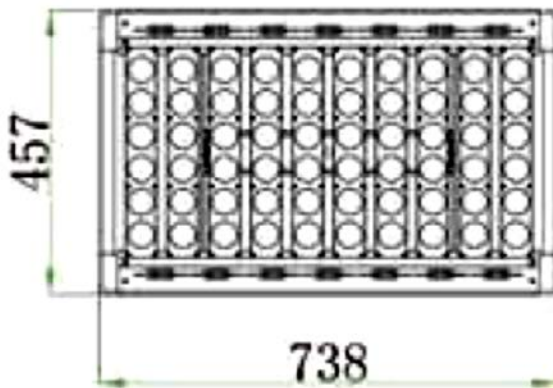
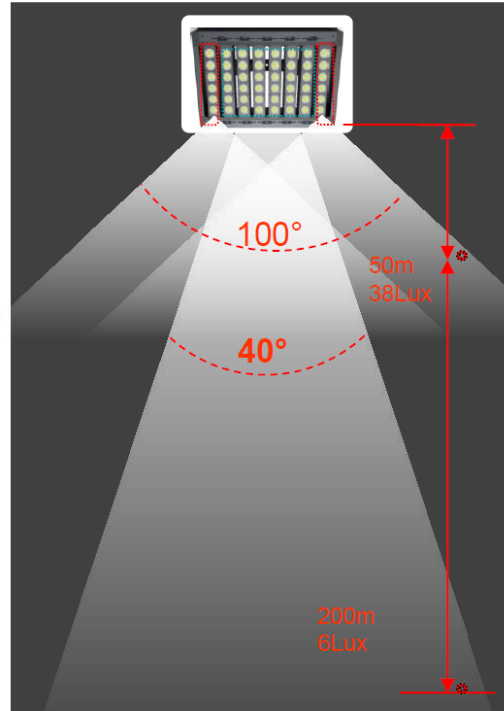

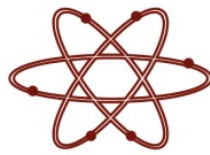

LEDLUMEN®
LED Technologie

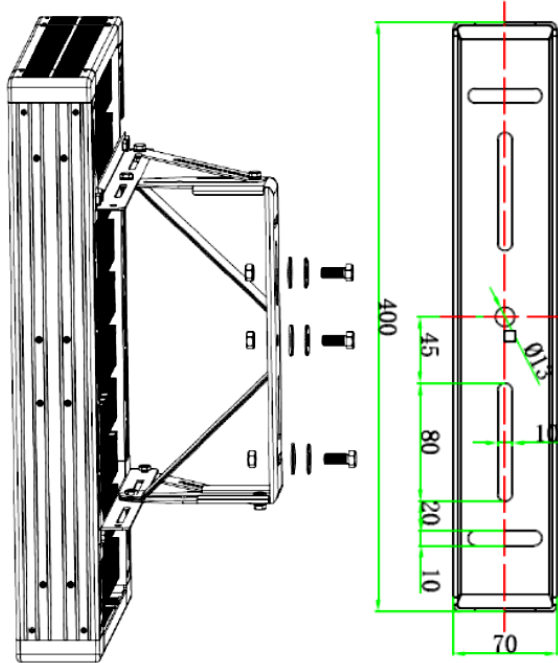

Right turn 45 degrees

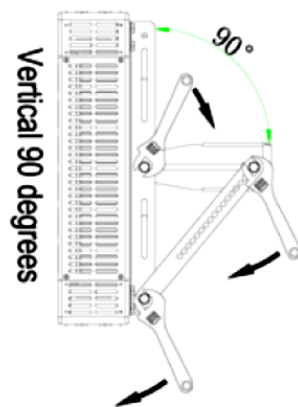

Vertical 90 degrees

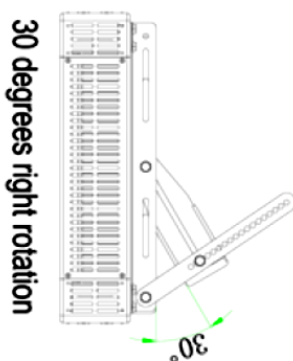

30 degrees right rotation



Right rotation 60 degrees

