

LEDLUMEN[®]
LED Technologie

Your brightness is our success!

LL-GL-F1-150W



TECHNISCHE DATEN

Model	LL-GL-F1-150W
LED Chips Quantity	210 PCS(7S19P) - 60°,90°,120°
LED Consumption	139W
System Consumption	150±5W
LED Luminous Efficiency	>145Lm/W
Lamp's Initial Flux	>20000Lm
Color Temperature	2700K, 3000K, 3500K, 4000K, 5000K, 5700K, 6500K
Lamp's Luminous Efficiency	≥120Lm /W
Lumen Maintenance	70% (50.000Hrs)
Color Rendering Index	Ra≥70
Light Design	Glass lens
View Angle	60°, 90°, 120°
Driver Working Temperature	-40° ~ +60°
Storage Temperature	-40° ~ +70°
IP Rating	IP65
Life-span	≥50,000Hrs
Material	Aluminum
Color of the lamp shell	Black/Gray
Mounting	Lifting type
Input Voltage/Frequency	90-305VAC; 47-63Hz
Input Current	1.33A/115VAC 0.69A/230VAC
Output Voltage	42~48V
Output Current	0~3A
Power Efficiency	≥93%
Power Factor	PF > 0.98/115VAC PF > 0.95/230VAC PF > 0.92/277VAC



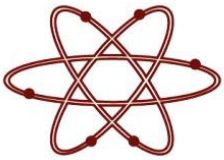

LL-GL-F1-150W

Lichtparameter

Beam Angle 60°

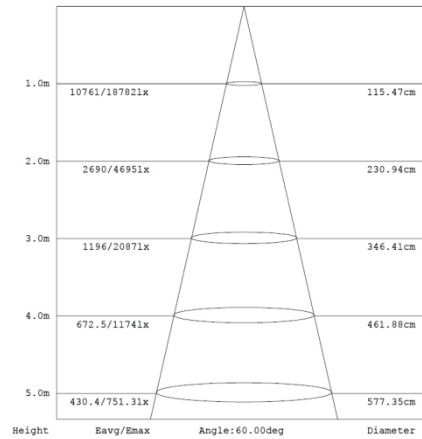
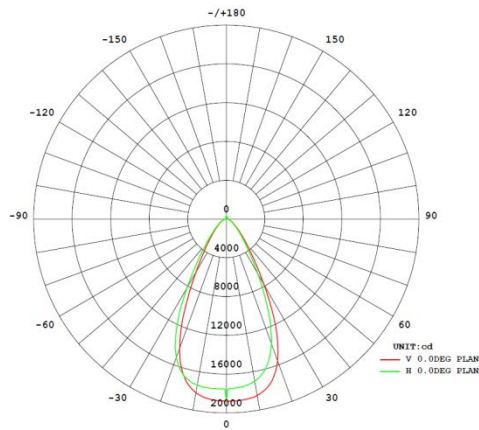

Beam Angle 90°

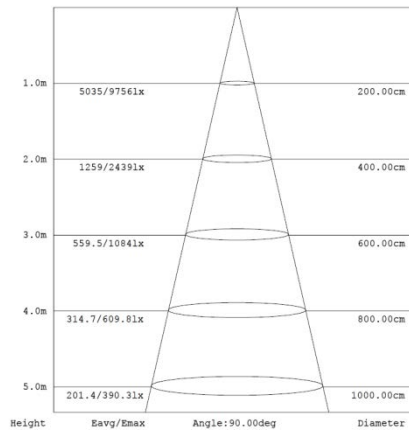
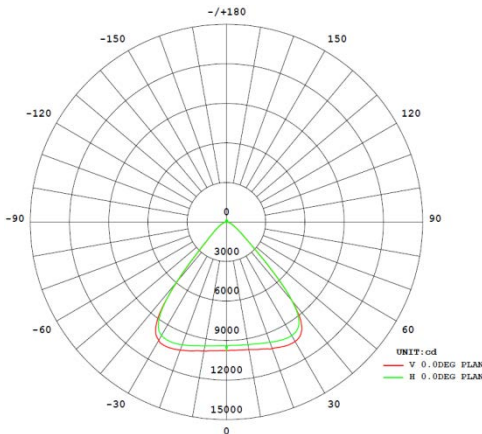

Beam Angle 90°

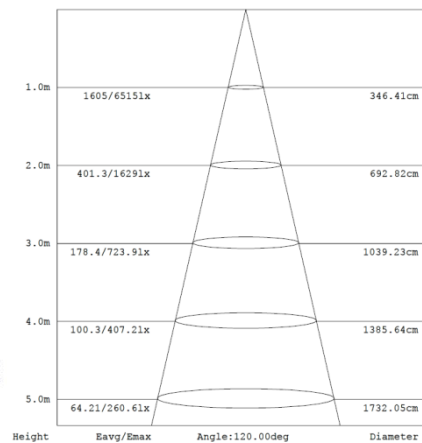
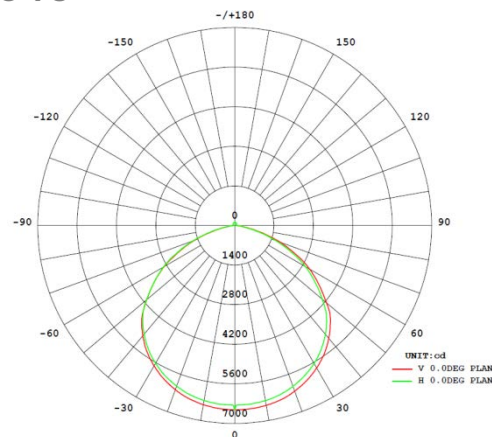

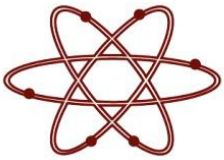

LL-GL-F1-150W

Bemaßung

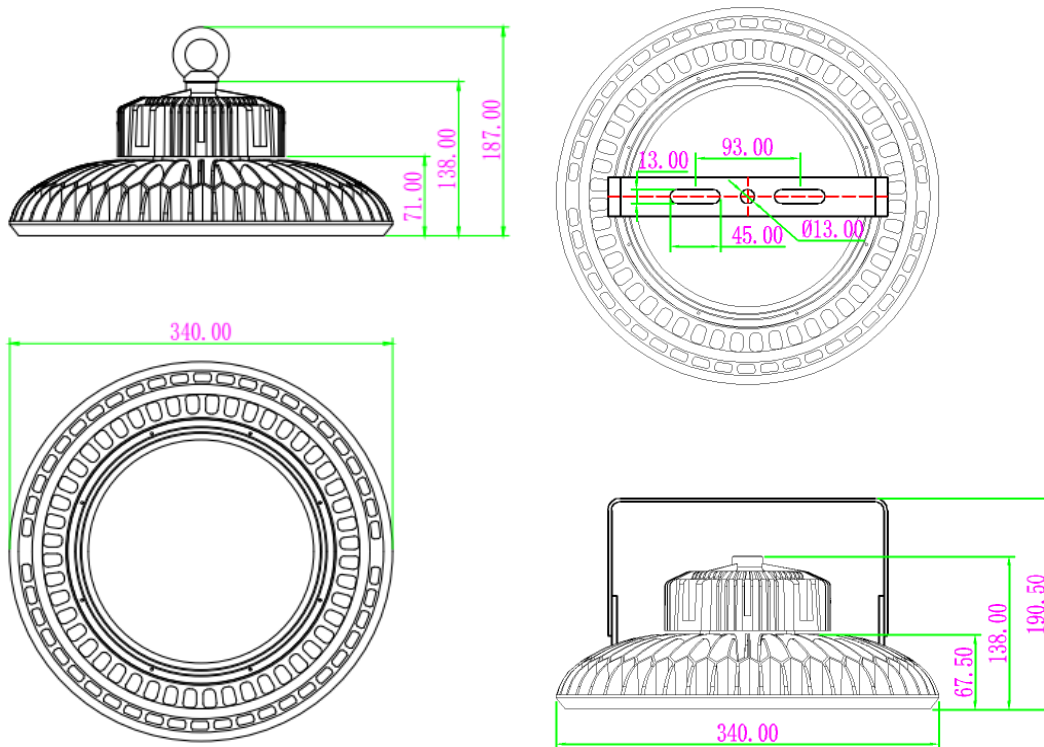

- Alle Strahler sind mit Meanwell Driver ausgerüstet
- Garanzzeit: 3 Jahre
- Schutzklasse IP65

