

LEDLUMEN[®]
LED Technologie

Your brightness is our success!

LL-TG3B-8

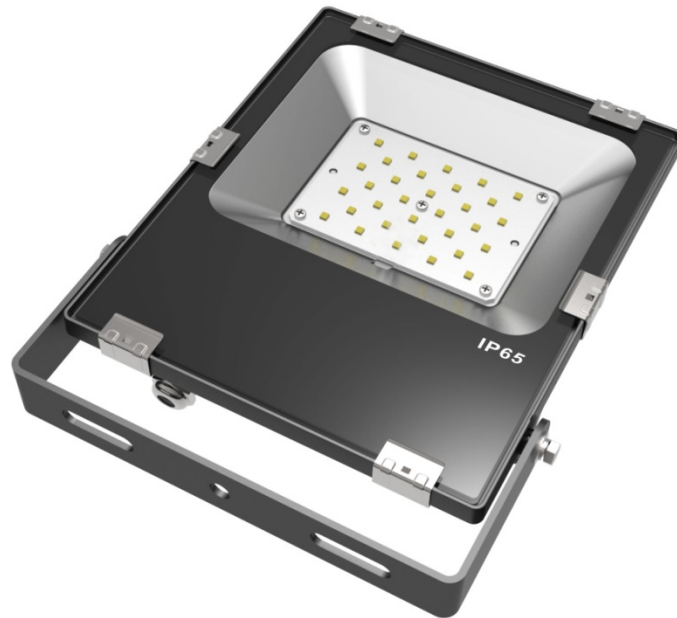

TECHNISCHE DATEN			
Model		LL-TG3B-8	
Product Specification	Material	AL + Glass	
	LED Type	SMD-3030	
	LED Quantity	240 pcs	
Electrical Parameters	Power	200W	
	Input Voltage	90-300VAC	
	Output Voltage	30-36VDC	
	Power Efficiency	>0.9	
Optical Parameters	Luminosity	25000Lm±10%	
	Illumination	5m	382Lux
		10m	96Lux
		15m	43Lux
	Light Efficiency	125Lm/w±10%	
	CRI	>70	
	Color Temperature	4000K/5000K/6000K	
Beam Angle	110°		
Package	Package Size (mm)	555*440*135mm	
	QTY of Package	1 pcx	
	Piece Weight (Kg)	7.12 kg	
	Net Weight (Kg)	7.72 kg	
	Gross Weight (Kg)	7.72 kg	
Lamp Type		III	
Installation		Bare	
IP Rate		IP65	
Lifespan		50.000h	
Working Temperature		-25° - +50°	



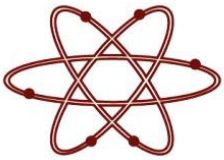

LL-TG3B-8

Bemaßung

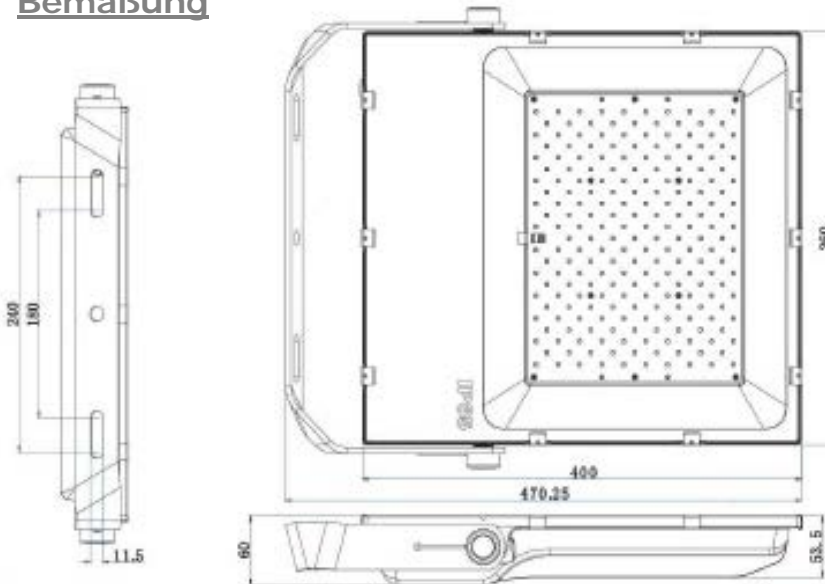

- Alle Lampen sind mit Meanwell Driver ausgerüstet
- Garantiezeit: 5 Jahre
- Schutzklasse IP65

