

**LEDLUMEN**<sup>®</sup>  
LED Technologie

*Your brightness is our success!*

## LL-TG3B-7

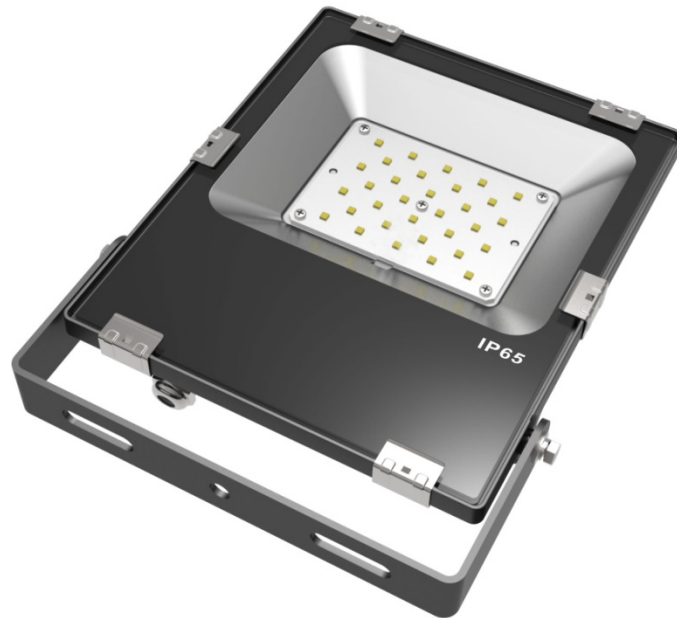

TECHNISCHE DATEN			
<b>Model</b>	LL-TG3B-7		
<b>Product Specification</b>	<b>Material</b>	AL + Glass	
	<b>LED Type</b>	SMD-3030	
	<b>LED Quantity</b>	150 pcs	
<b>Electrical Parameters</b>	<b>Power</b>	150W	
	<b>Input Voltage</b>	90-300VAC	
	<b>Output Voltage</b>	30-36VDC	
	<b>Power Efficiency</b>	>0.9	
<b>Optical Parameters</b>	<b>Luminosity</b>	18000Lm±10%	
	<b>Illumination</b>	<b>5m</b>	262Lux
		<b>10m</b>	66Lux
		<b>15m</b>	30Lux
	<b>Light Efficiency</b>	120Lm/w±10%	
	<b>CRI</b>	>70	
	<b>Color Temperature</b>	4000K/5000K/6000K	
<b>Beam Angle</b>	110°		
<b>Package</b>	<b>Package Size (mm)</b>	510*340*135mm	
	<b>QTY of Package</b>	1 pcx	
	<b>Piece Weight (Kg)</b>	5.82 kg	
	<b>Net Weight (Kg)</b>	6.42 kg	
	<b>Gross Weight (Kg)</b>	6.42 kg	
<b>Lamp Type</b>	III		
<b>Installation</b>	Bare		
<b>IP Rate</b>	IP65		
<b>Lifespan</b>	50.000h		
<b>Working Temperature</b>	-25° - +50°		



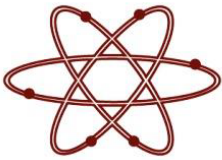

## LL-TG3B-7

### Bemaßung

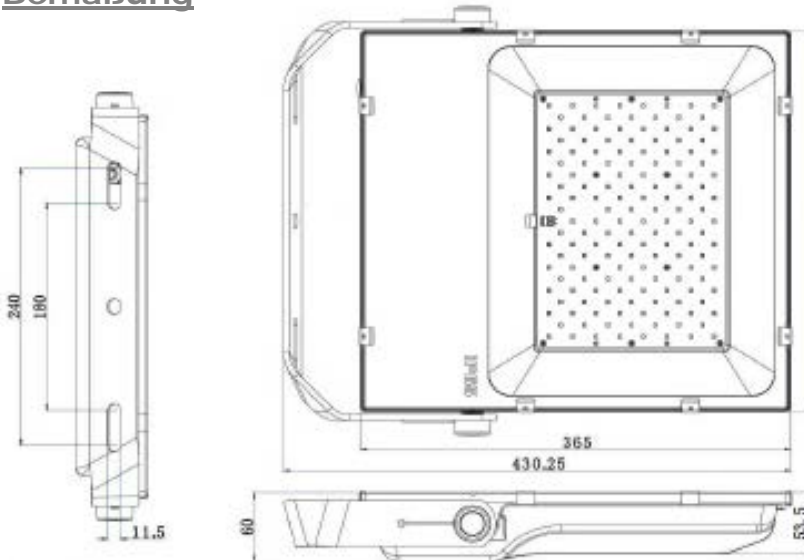

- Alle Lampen sind mit Meanwell Driver ausgerüstet
- Garantiezeit: 5 Jahre
- Schutzklasse IP65

