

LEDLUMEN[®]
LED Technologie

Your brightness is our success!

LL-TG3B-4

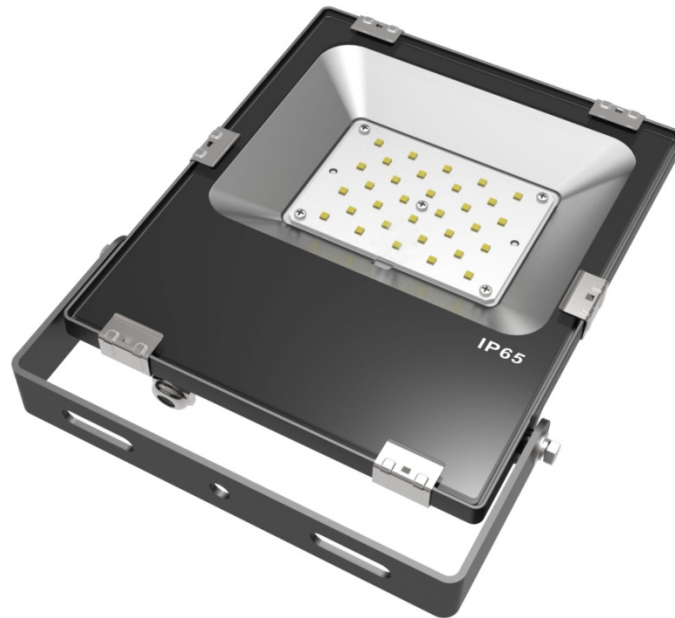

TECHNISCHE DATEN

Model		LL-TG3B-4	
Product Specification	Material	AL + Glass	
	LED Type	SMD-3030	
	LED Quantity	50 pcs	
Electrical Parameters	Power	50W	
	Input Voltage	100-240VAC	
	Output Voltage	30-36VDC	
	Power Efficiency	>0.9	
Optical Parameters	Luminosity	5750Lm±10%	
	Illumination	5m	87Lux
		10m	22Lux
		15m	9Lux
	Light Efficiency	115Lm/w±10%	
	CRI	>70	
	Color Temperature	4000K/5000K/6000K	
Beam Angle	110°		
Package	Package Size (mm)	530*365*255mm	
	QTY of Package	8 pcx	
	Piece Weight (Kg)	2.08 kg	
	Net Weight (Kg)	16.64 kg	
	Gross Weight (Kg)	17.62 kg	
Lamp Type	III		
Installation	Bare		
IP Rate	IP65		
Lifespan	50.000h		
Working Temperature	-25° - +50°		



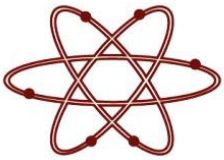

LL-TG3B-4

Bemaßung

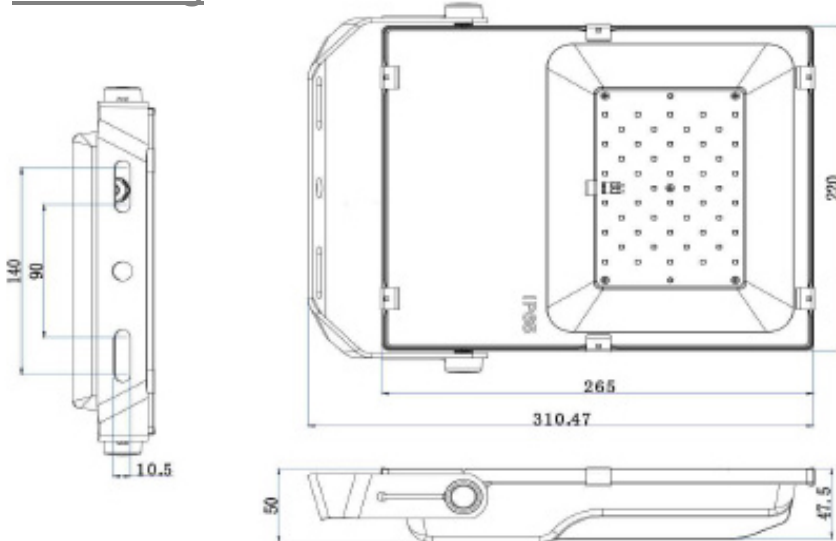

- Alle Lampen sind mit Meanwell Driver ausgerüstet
- Garantiezeit: 5 Jahre
- Schutzklasse IP65

