

**LEDLUMEN**<sup>®</sup>  
LED Technologie

*Your brightness is our success!*

## LL-TG3B-2

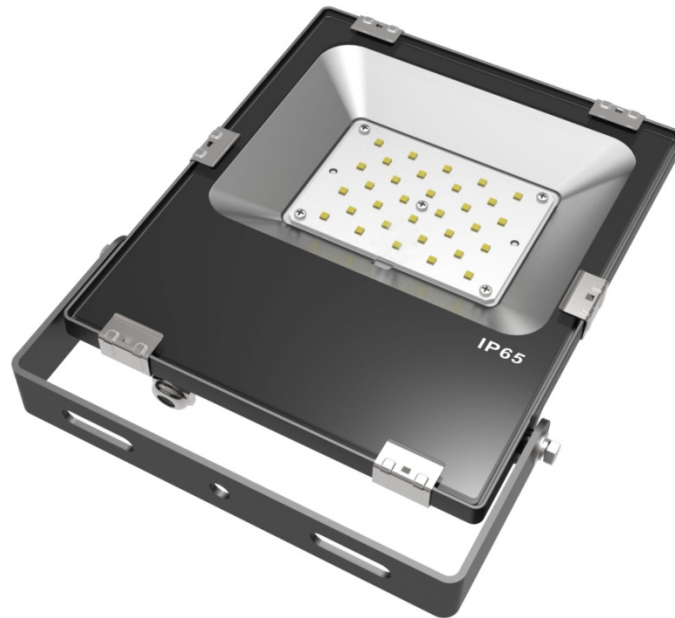

TECHNISCHE DATEN			
<b>Model</b>		LL-TG3B-2	
<b>Product Specification</b>	<b>Material</b>	AL + Glass	
	<b>LED Type</b>	SMD-3030	
	<b>LED Quantity</b>	20 pcs	
<b>Electrical Parameters</b>	<b>Power</b>	20W	
	<b>Input Voltage</b>	100-240VAC	
	<b>Output Voltage</b>	30-36VDC	
	<b>Power Efficiency</b>	>0.9	
<b>Optical Parameters</b>	<b>Luminosity</b>	2200Lm±10%	
	<b>Illumination</b>	<b>5m</b>	35Lux
		<b>10m</b>	9Lux
		<b>15m</b>	4Lux
	<b>Light Efficiency</b>	110Lm/w±10%	
	<b>CRI</b>	>70	
	<b>Color Temperature</b>	4000K/5000K/6000K	
<b>Beam Angle</b>	110°		
<b>Package</b>	<b>Package Size (mm)</b>	515*380*260mm	
	<b>QTY of Package</b>	20 pcx	
	<b>Piece Weight (Kg)</b>	1.08 kg	
	<b>Net Weight (Kg)</b>	21.6 kg	
	<b>Gross Weight (Kg)</b>	22.58 kg	
<b>Lamp Type</b>		III	
<b>Installation</b>		Bare	
<b>IP Rate</b>		IP65	
<b>Lifespan</b>		50.000h	
<b>Working Temperature</b>		-25° - +50°	



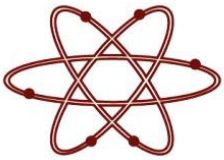

## LL-TG3B-2

### Bemaßung

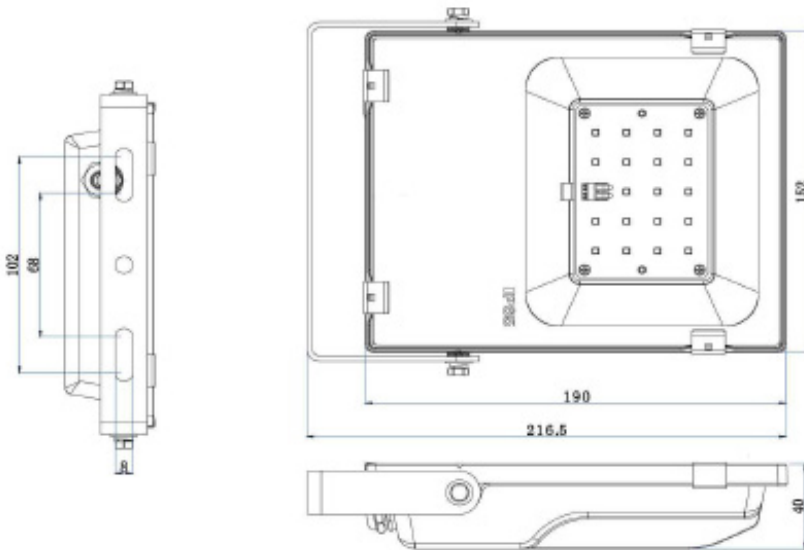

- Alle Lampen sind mit Meanwell Driver ausgerüstet
- Garantiezeit: 5 Jahre
- Schutzklasse IP65

