

## LED Flutlicht

### LL-FLS-500W



- ▶ **Kühlung:** SONY 4D, aktive Wärmeableitungstechnologie, modularisiertes Baudesign, größtmögliche Kühlfläche
- ▶ **Optische Linse:** Japan calculus optical DIWL Linse, Lichtdurchlässigkeit von PMMA bis zu 98%.
- ▶ **Beschichtung:** hochfeste Struktur beschichtet mit korrosionsbeständigem Polyesterpulver, echter Korrosionsschutz
- ▶ **Blendung:** exzellentes optisches Design, niedriger UGR, kein Flackern bei Zeitlupenaufnahmen, geeignet für HDTV Live Broadcasting besonders geeignet für Tennisplätze, Fußballplätze, Stadien, Sportplätze, Tunnel, Hochmastbeleuchtung, Leuchttürme und Häfen
- ▶ CE, (TÜV), RoHS, FCC, DLC und IP67 zertifiziert, 3 Jahre Garantie

<b>Input Voltage</b>	90-305 VAC, 50/60 Hz
<b>AC Current</b>	4A/115VAC 2A/230VAC 1.2A/277VAC
<b>Inrush Current</b>	Cold Start 150A(twidth=570u's measured at 50% peak) at 230VAC
<b>Leakage Current</b>	<0.75mA/277VAC
<b>Power Factor</b>	PF>0.98/115VAC,PF>0.95/230VAC at full lead
<b>LED Light Source</b>	CREE Xlamp
<b>LED Quantity</b>	60PCS
<b>LED Power</b>	500W
<b>Total System Power</b>	528W
<b>Power Supply</b>	MeanWell
<b>Driver Quantity</b>	2PCS
<b>LED Luminous Efficiency</b>	130 -150 lm /W
<b>LED Initial Luminous Flux</b>	65000-75000 Lm
<b>Illuminance Uniformity</b>	>0.8
<b>Color Temperature</b>	2700、3000、3500、4000、5000、5700、6500K
<b>Color Rendering Index</b>	80 or <93
<b>Light Distribution</b>	Asymmetric / Rectangular
<b>Beam Angle</b>	10°/24°/38°/60°/90°
<b>LED Junction Temperature</b>	≤70°C (@ Ta=25°C)
<b>Working Temperature</b>	-40°C ~ +65°C
<b>Storage Temperature</b>	-40°C ~ +65°C (Best 25°C)
<b>IP Rating</b>	IP67
<b>Net weight</b>	18Kg ohne Montagebügel
<b>Dimming</b>	0-10V, 1-10V, Triac/DALI dimming models
<b>Lifespan</b>	>80,000H
<b>Power Cord</b>	SJT 3X1.31mm2(16AWG) triple shield wire
<b>Shell Color</b>	Black/Silver/Grey



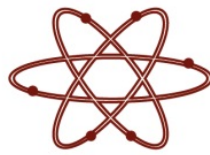

# LED Flutlicht

## Photometric Results

### Beam Angel of 38°

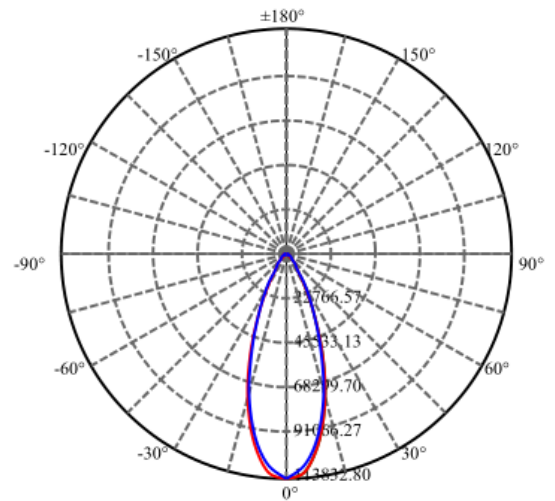
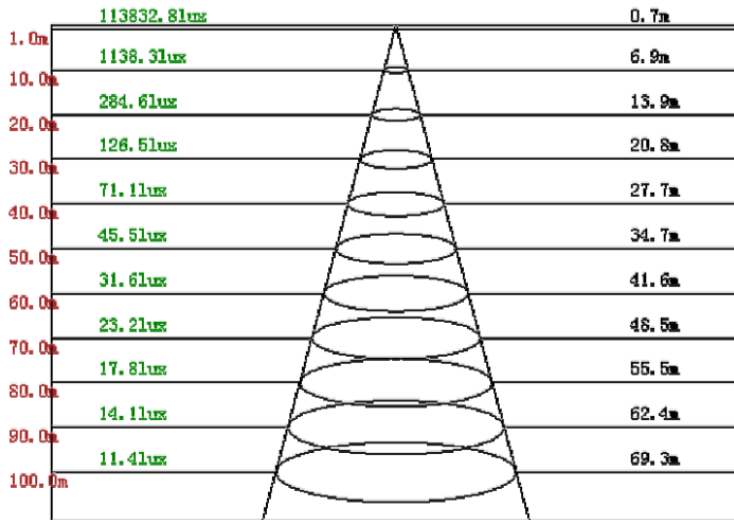

### Beam Angel of 60°

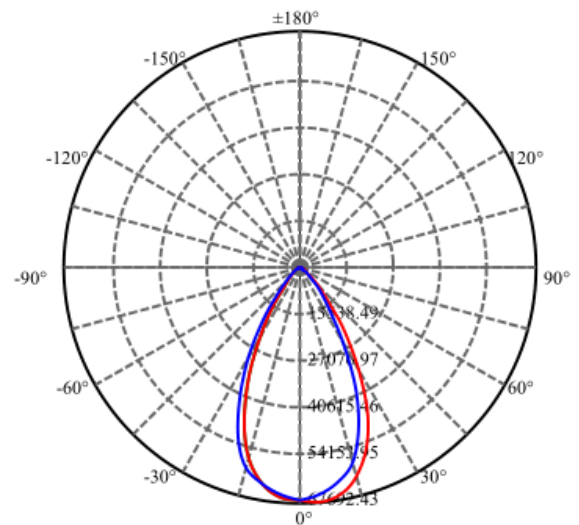
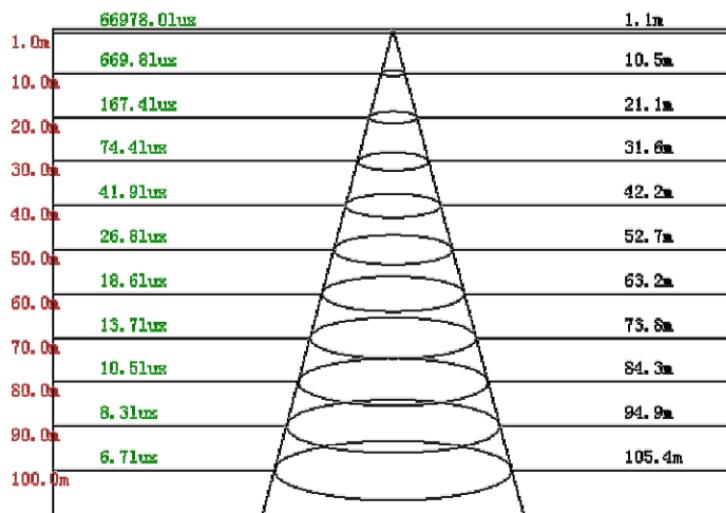

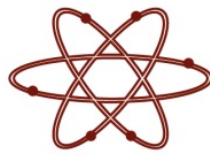

**LEDLUMEN®**  
LED Technologie

# LED Flutlicht

## Beam Angle

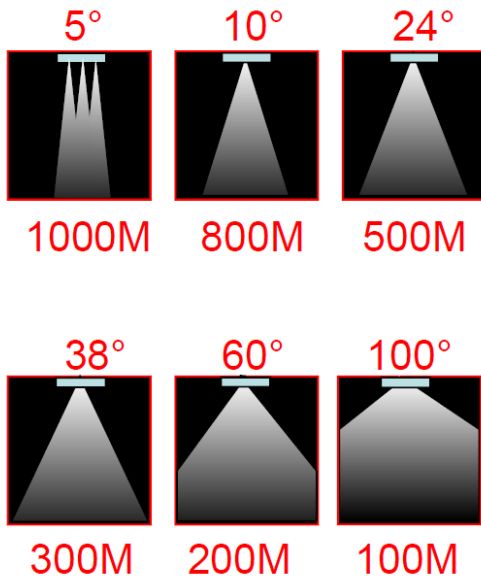

Multi Angle Applications

## Two Angle Showing

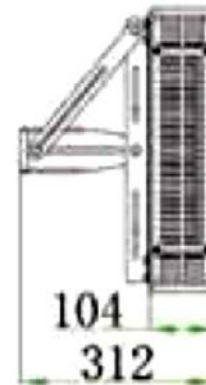
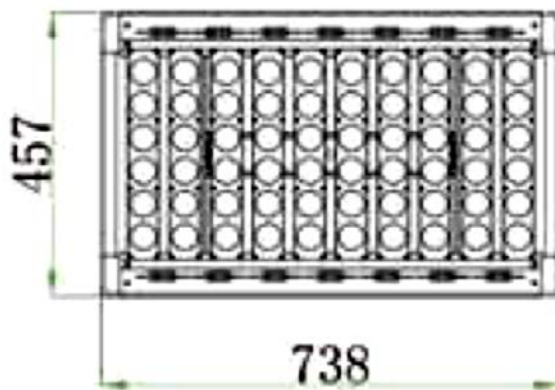
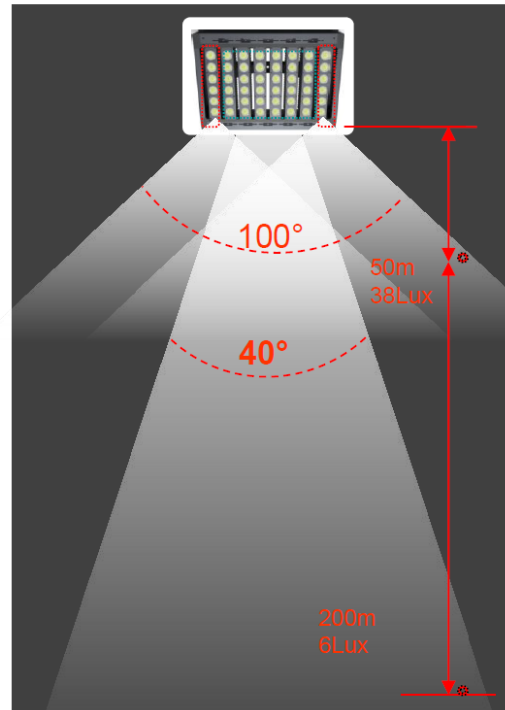

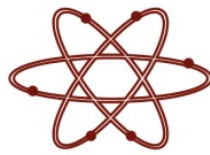

**LEDLUMEN®**  
LED Technologie

